

Anbauanleitung: Seilwindenanbausatz IVECO Daily ab2019

AL: 2212-03

Best.Nr.: 16-9520

Montagezeit: ca. 480 min.

**Hier sehen sie den fertig montierten Seilwindenanbausatz.
Bevor sie mit der Montage beginnen, lesen sie bitte diese Anleitung und das
Benutzerhandbuch der Seilwinde gut durch.**

Achtung:

**Bei Fahrten im öffentlichen Straßenverkehr muß das Rollenseilfenster mit der
Kunststoffabdeckung Best.Nr.: 15-905 abgedeckt werden.**

*Before you start fitting, please read and understand this instruction manual and the owners
manual of the winch.*

Attention:

The roller failead must be covered (with the cover Nr. 15-905) when driving on public roads!



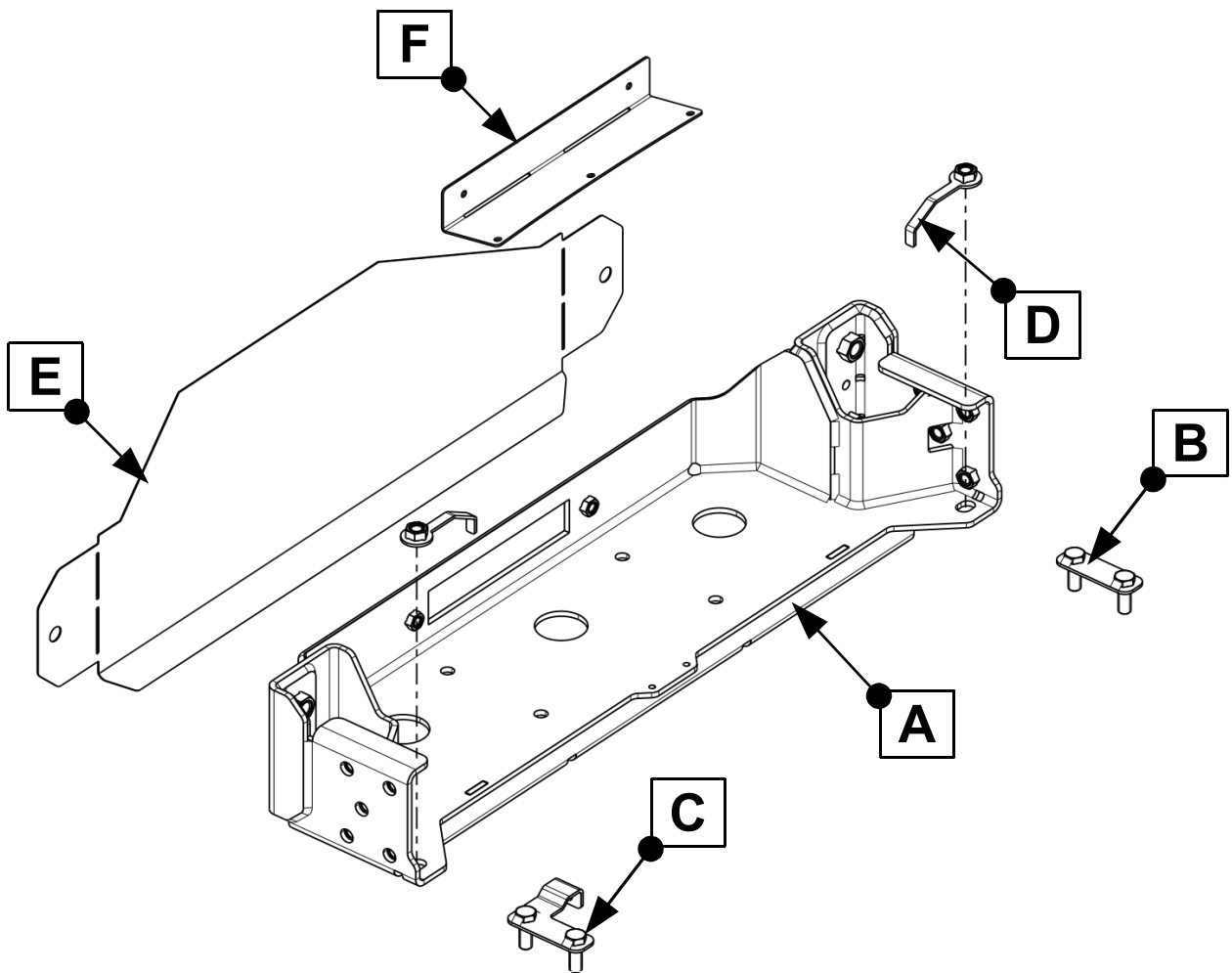

Stückliste

16-952

Schraubensatz

1x Windenaufnahme (A)
 1x Gewindeplatte rechts (B)
 1x Gewindeplatte links (C)
 2x Befestigungsblech (D)
 1x Schablone (E)
 1x Kennzeichenhalter (F)

1x 300mm Gummidichtung S-583 11x7
 1x 600mm Kederband klein
 mit Stahleinlage (Würth Nr: 09610025)

1x 2-F02943, Kabelhalter
 1x 1-50295875 Sicherung 400A

1x Anbauanleitung 2212
 1x Gutachten+Aufkleber

5x Kabelbinder 3,6 x 202
 1x Ringkabelschuh M8 x 35²
 1x Bundmutter M8
 5x Schraube M6 x 16
 10x Scheibe M6
 5x Federring M6
 5x Mutter M6

Für Rollenseilfenster:
 2x Schraube M10 x 30
 2x Scheibe M10
 2x Federring M10

Schrauben Anzugsmomente siehe letzte Seite!
For torque information please see last page!



2 **Vorderen Radeinbau ausbauen / Remove front mudgarde!
Das Gleiche an der rechten Seite! / The same at the right side!**

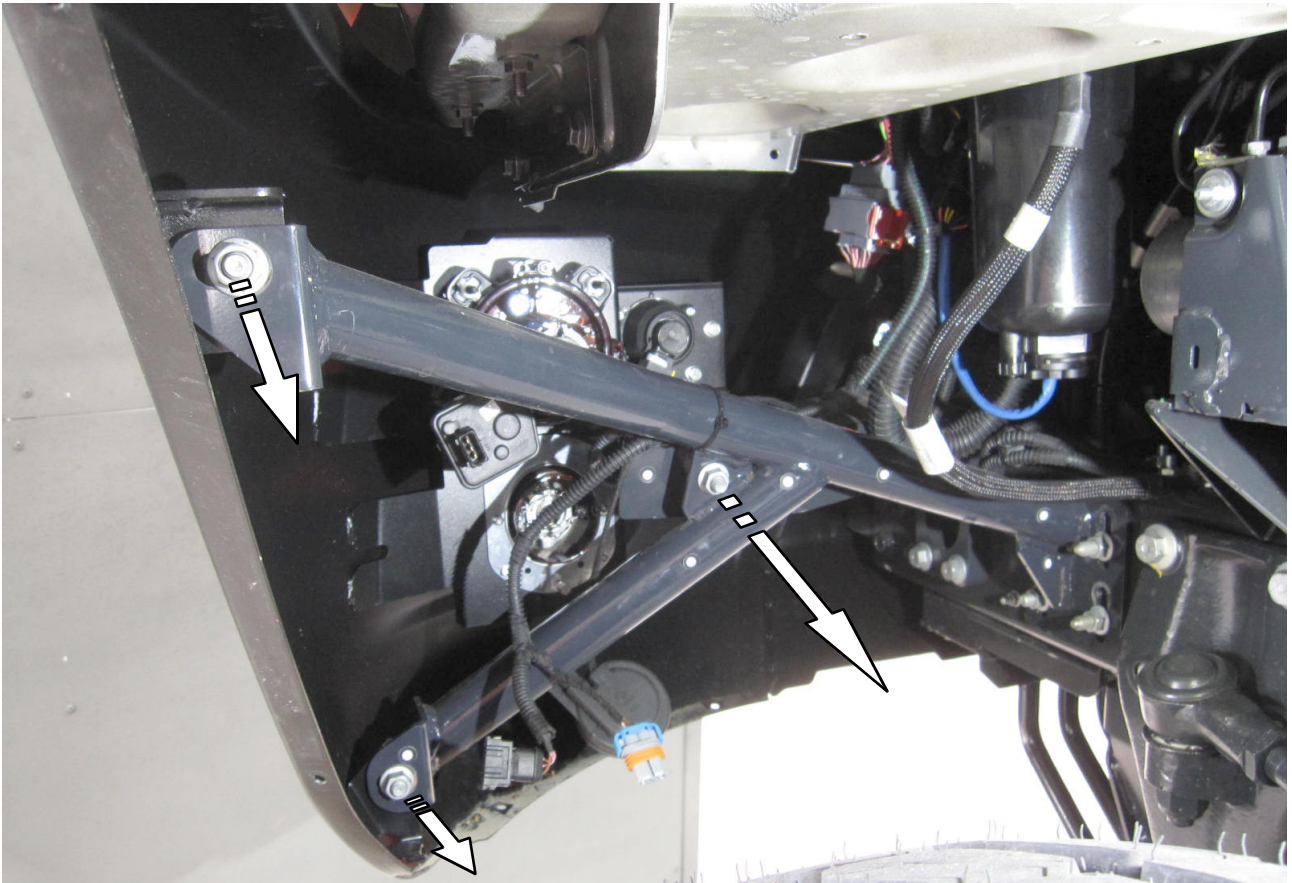

3

Schrauben entfernen! / Remove the screws!
Das Gleiche an der rechten Seite! / The same at the right side!



4

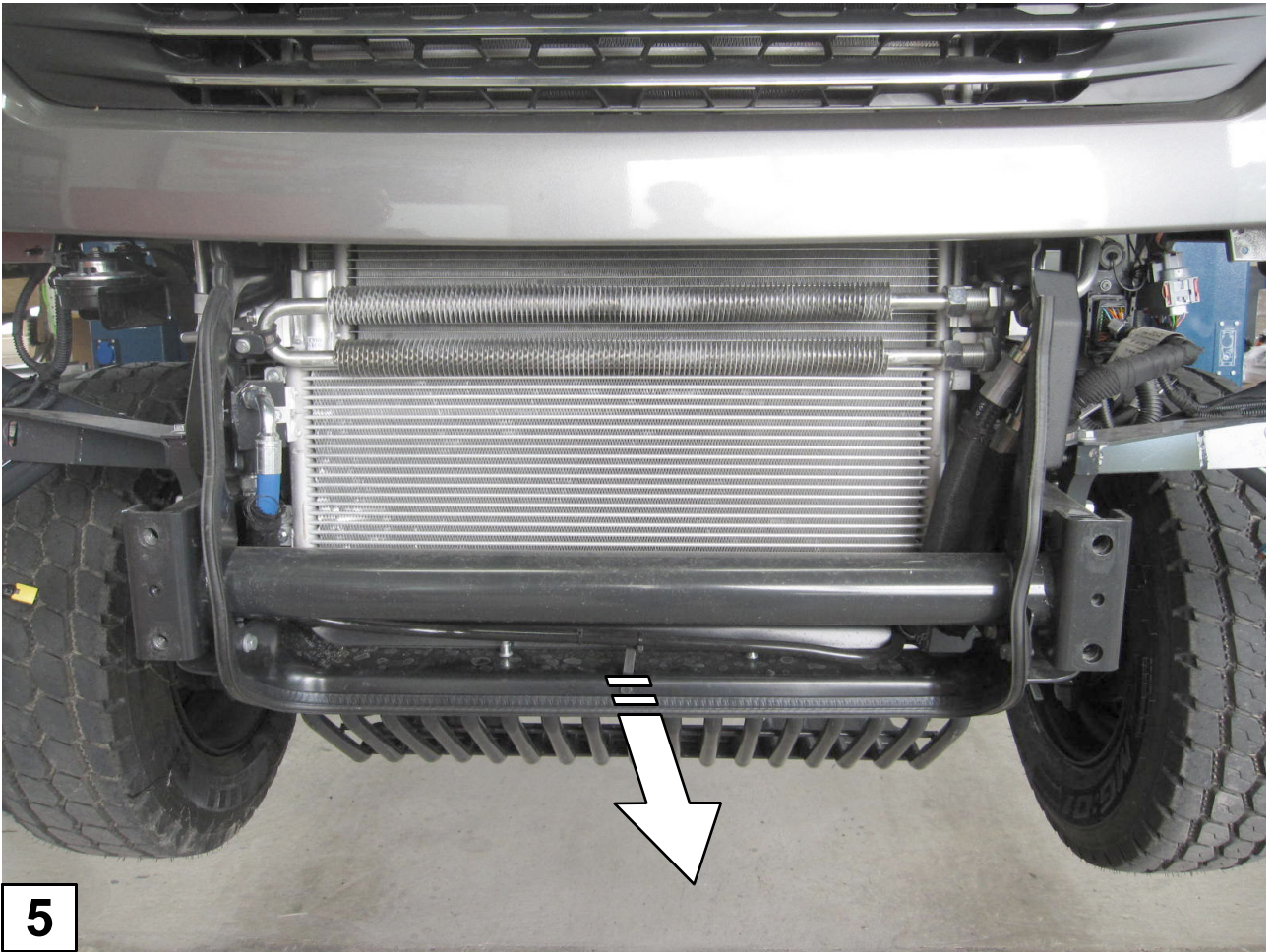

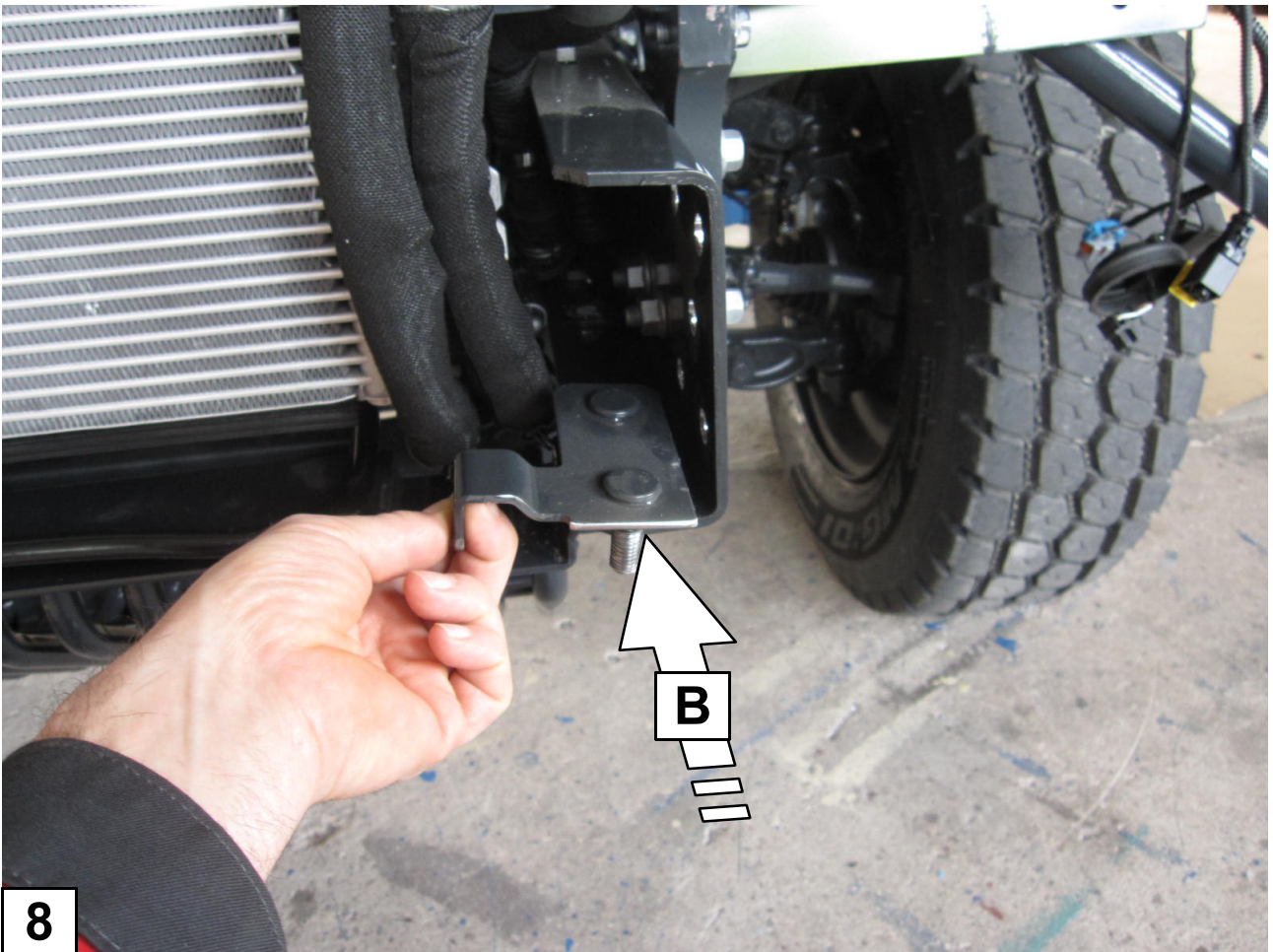
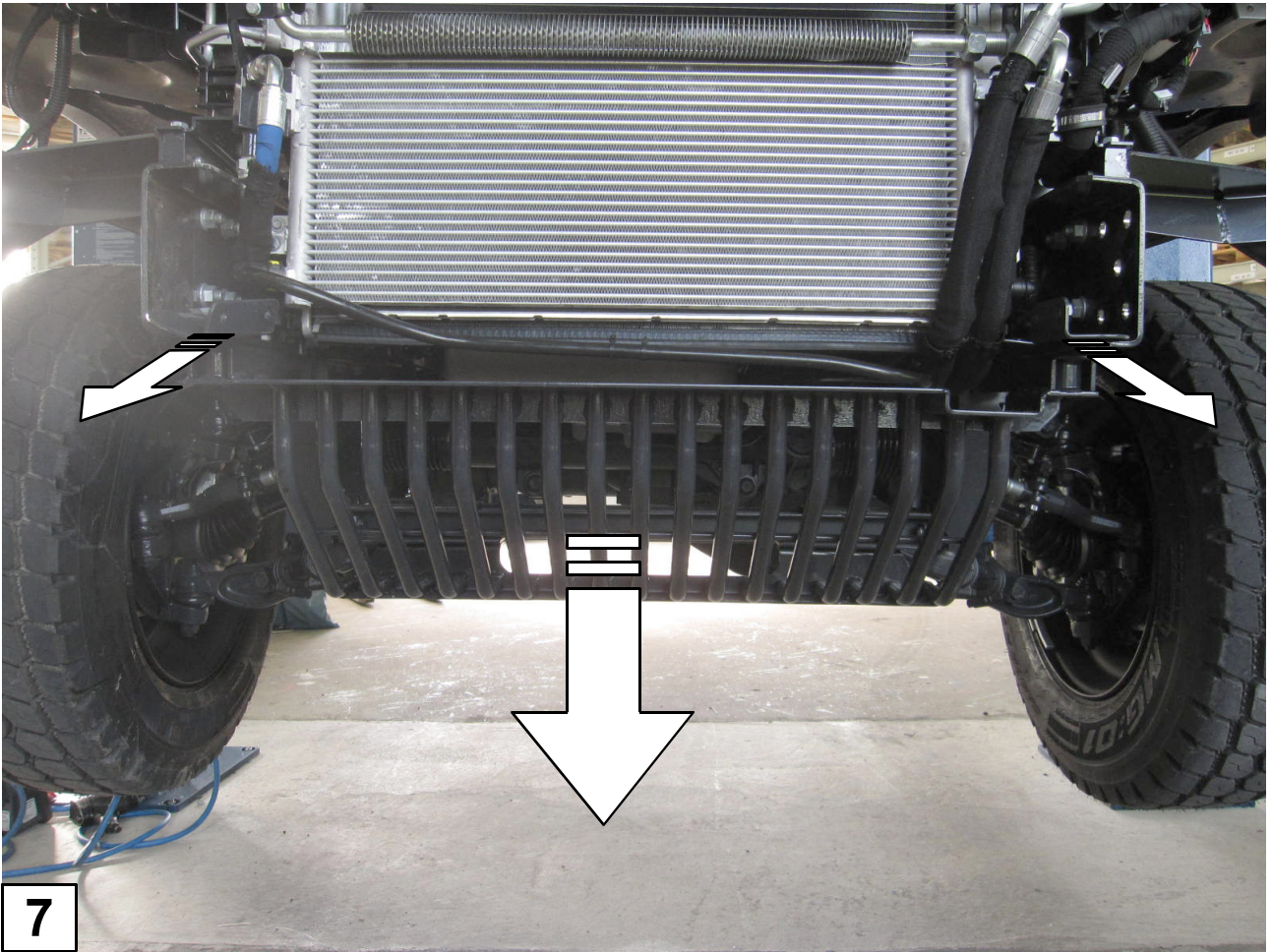

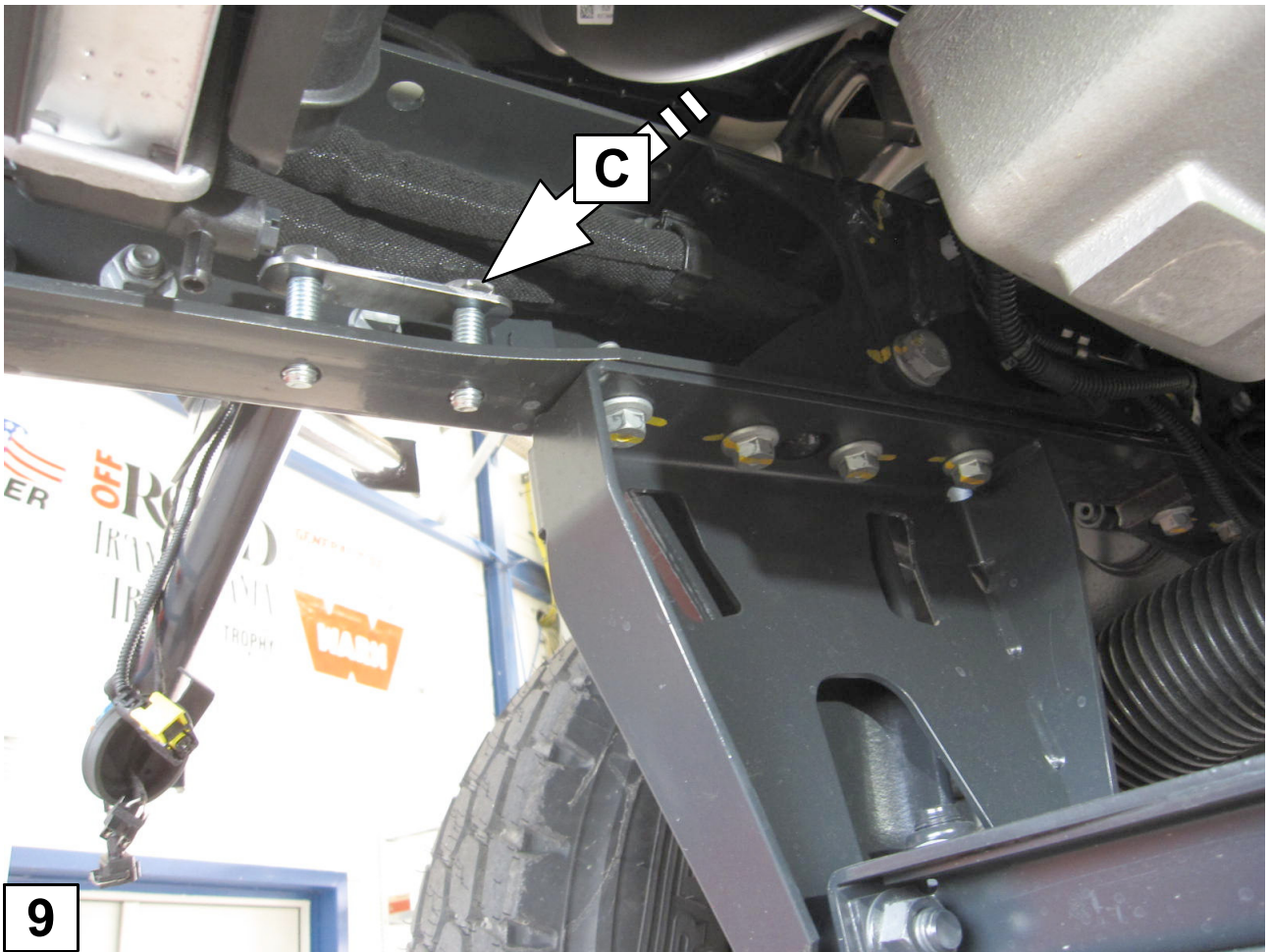

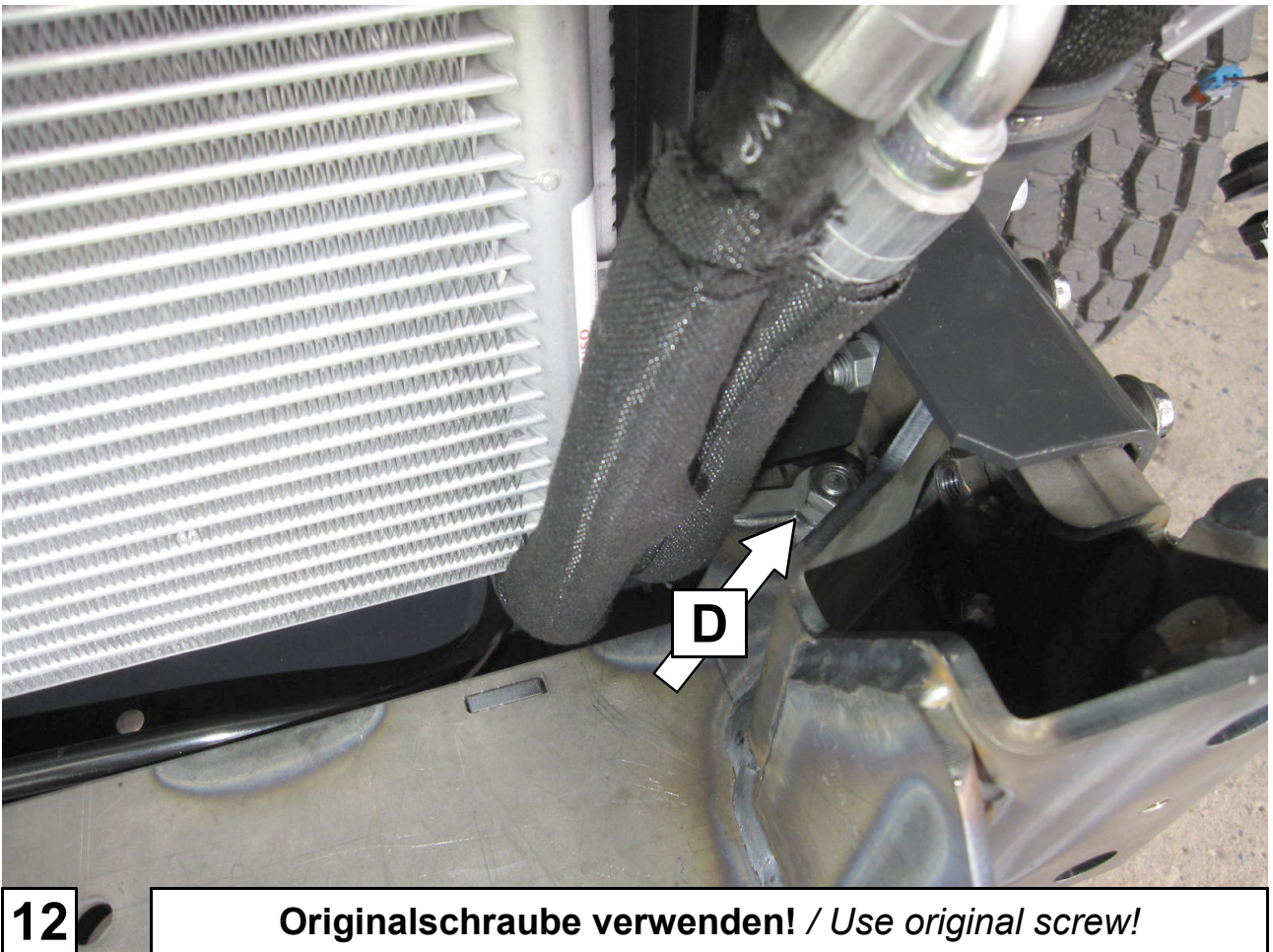
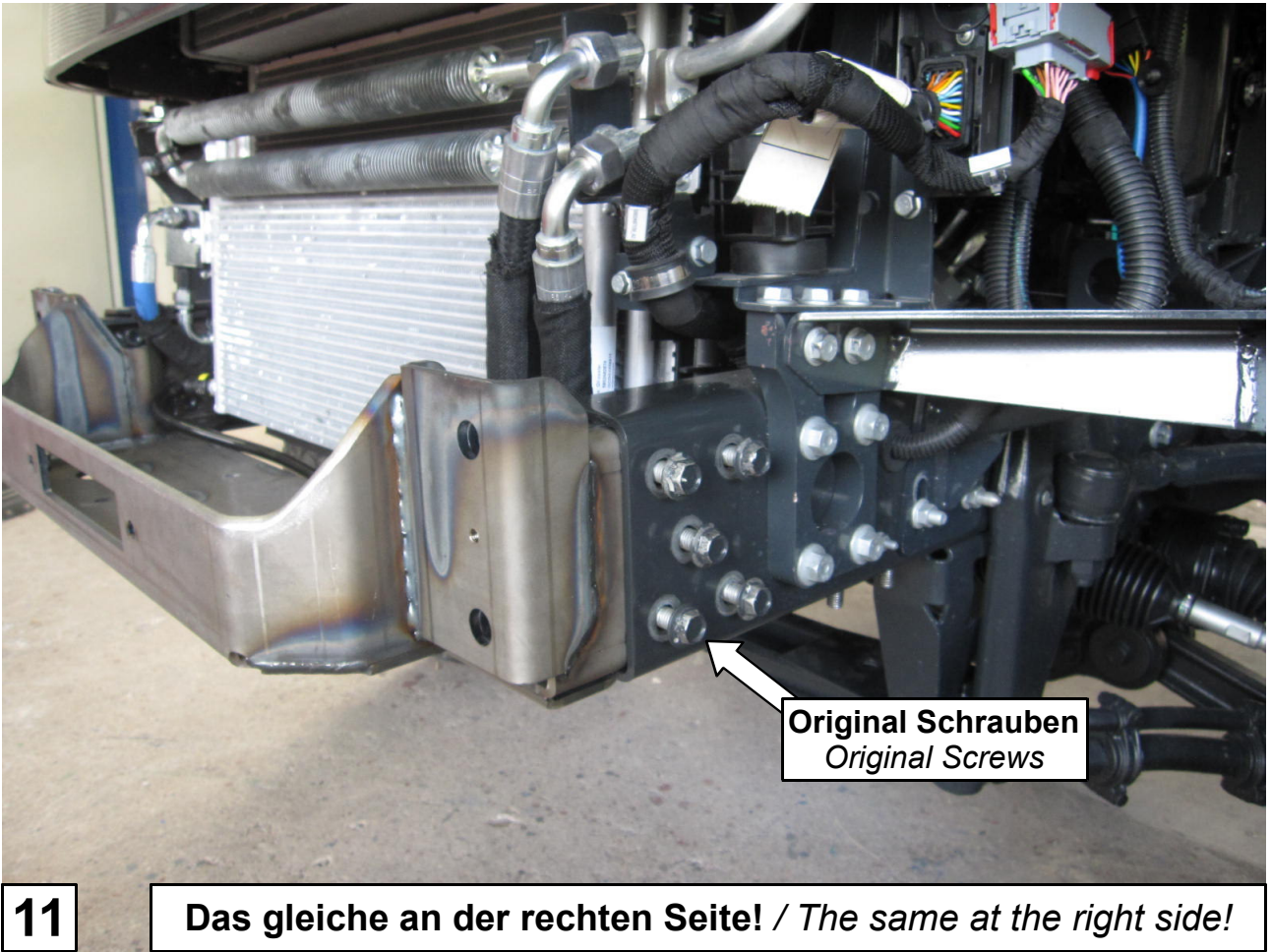

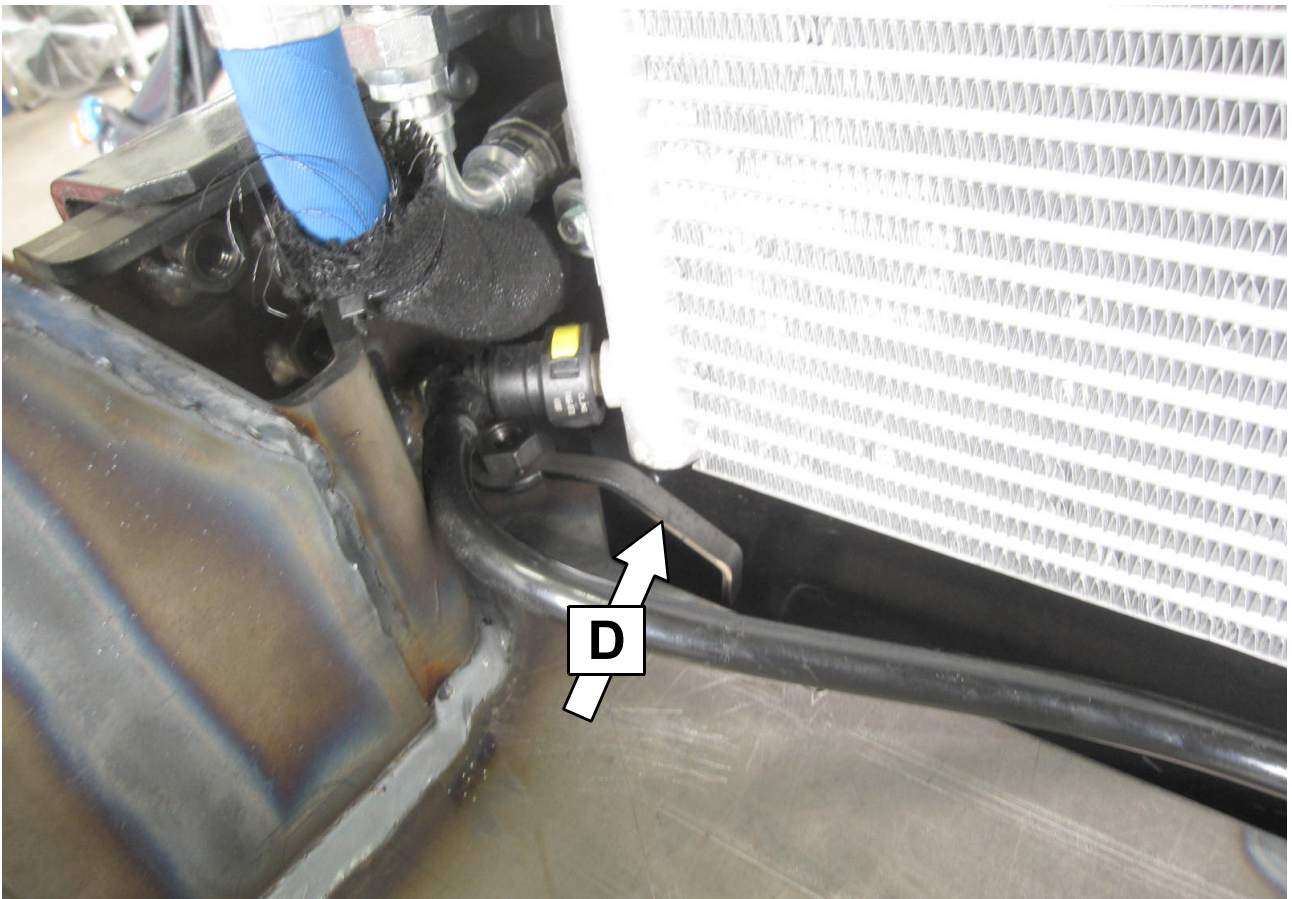

13

Originalschraube verwenden! / Use original screw!

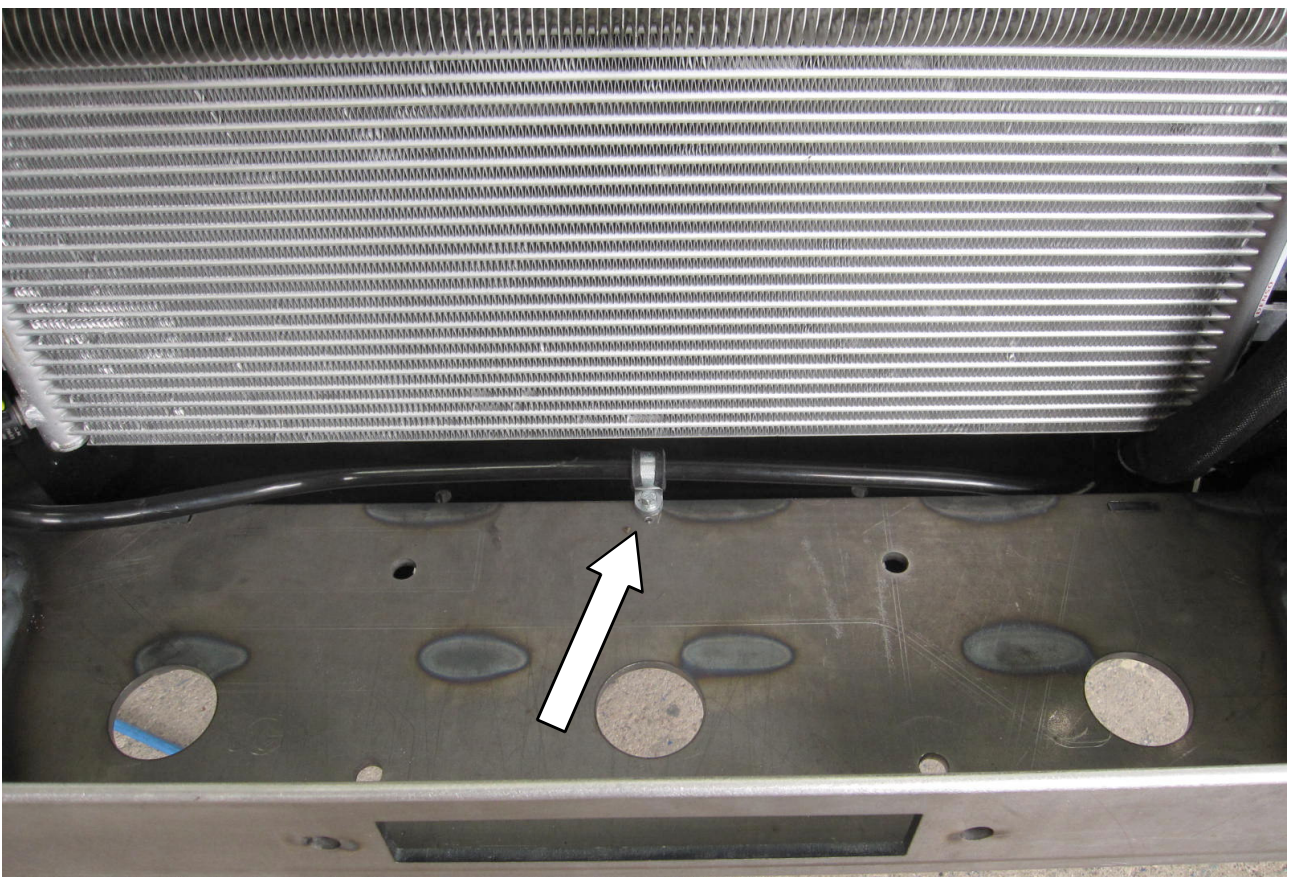

14

**Mit Kabelbindern oder Schelle befestigen!
Secure with cable ties or clamp!**

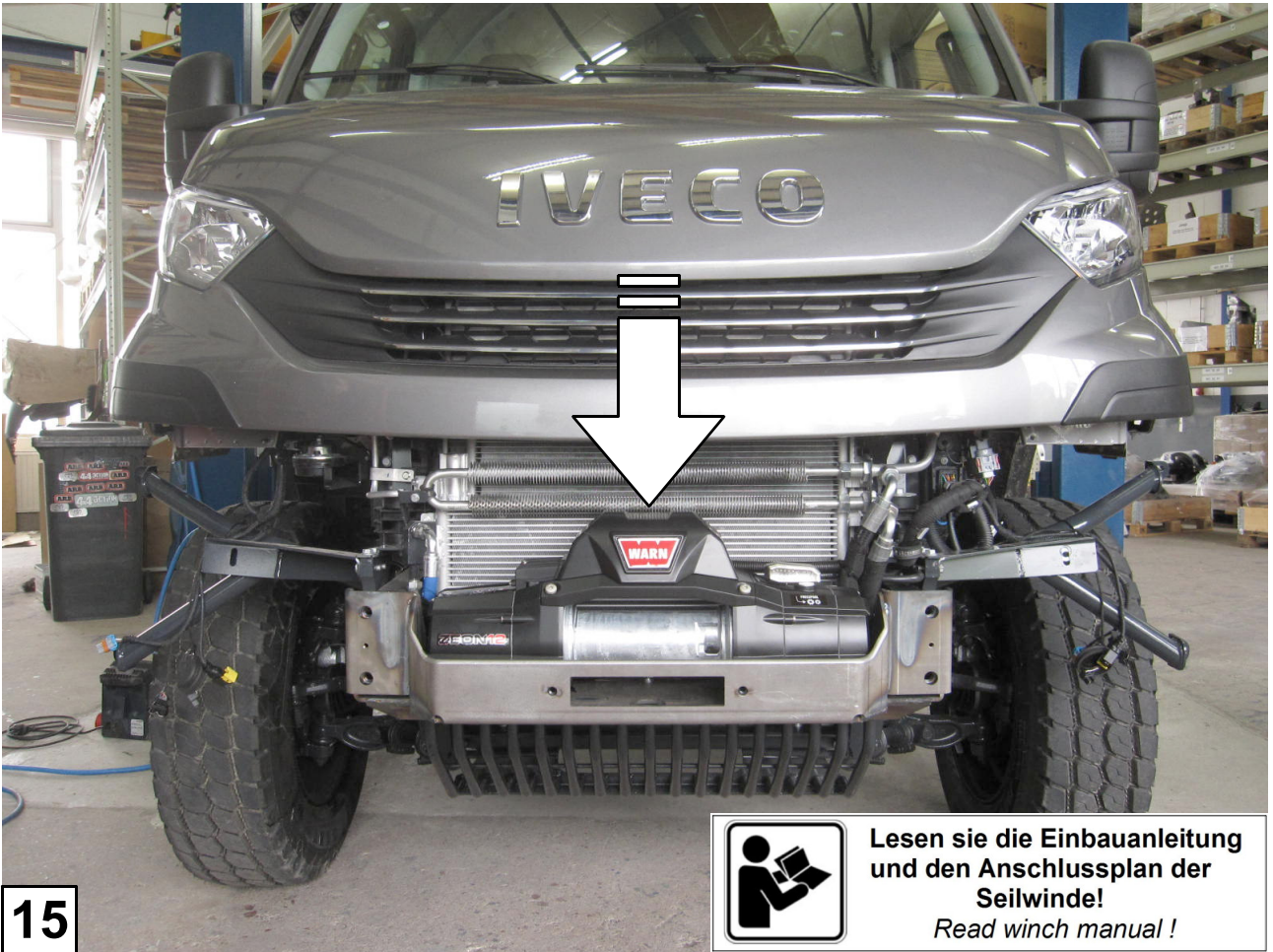

15



Lesen sie die Einbauanleitung
und den Anschlussplan der
Seilwinde!
Read winch manual !



16

Kabel befestigen! / *Fix the cable!*

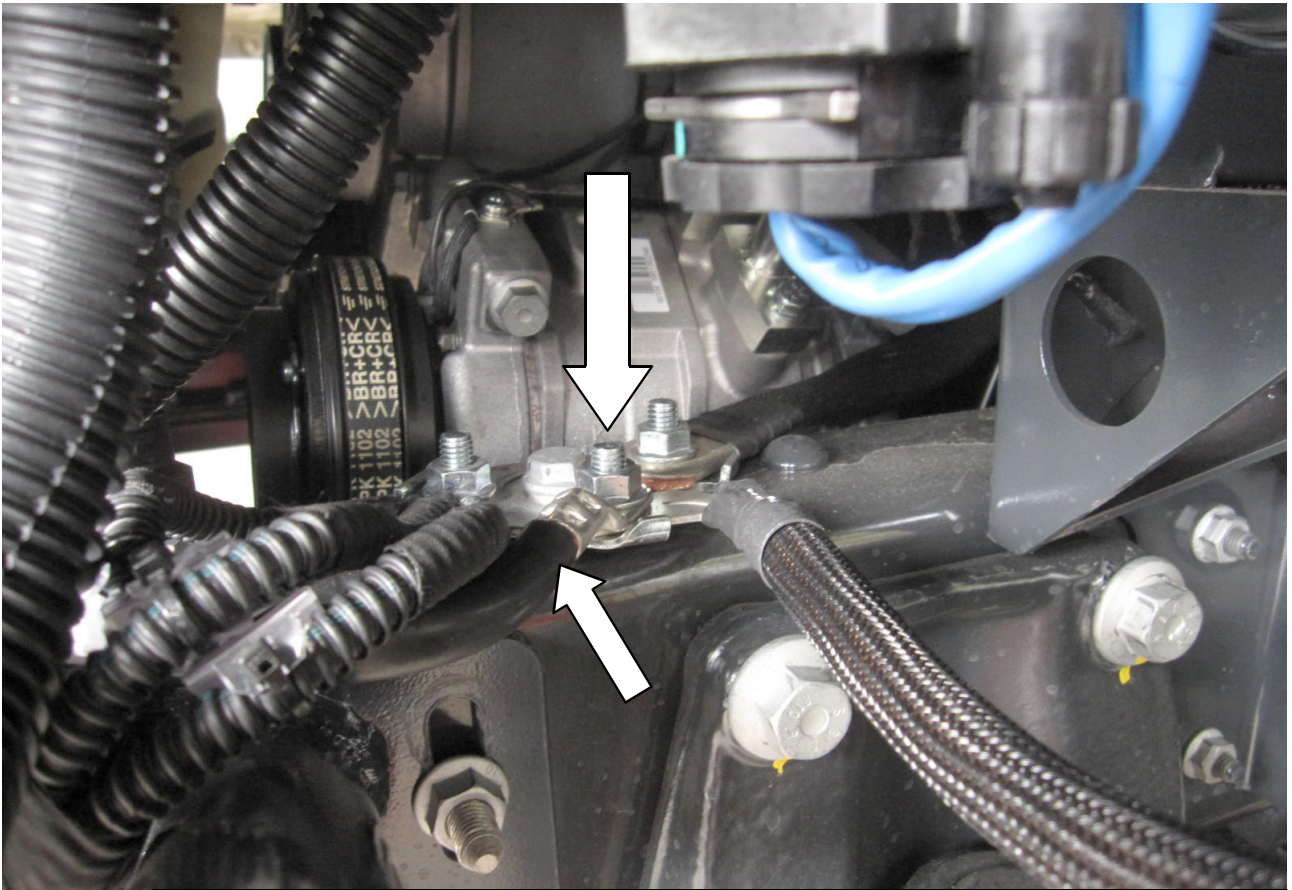

17

Massekabel evtl.kürzen und befestigen!
If necessary, shorten and connect the ground cable!



18

Sicherung entfernen! / Remove fuse!

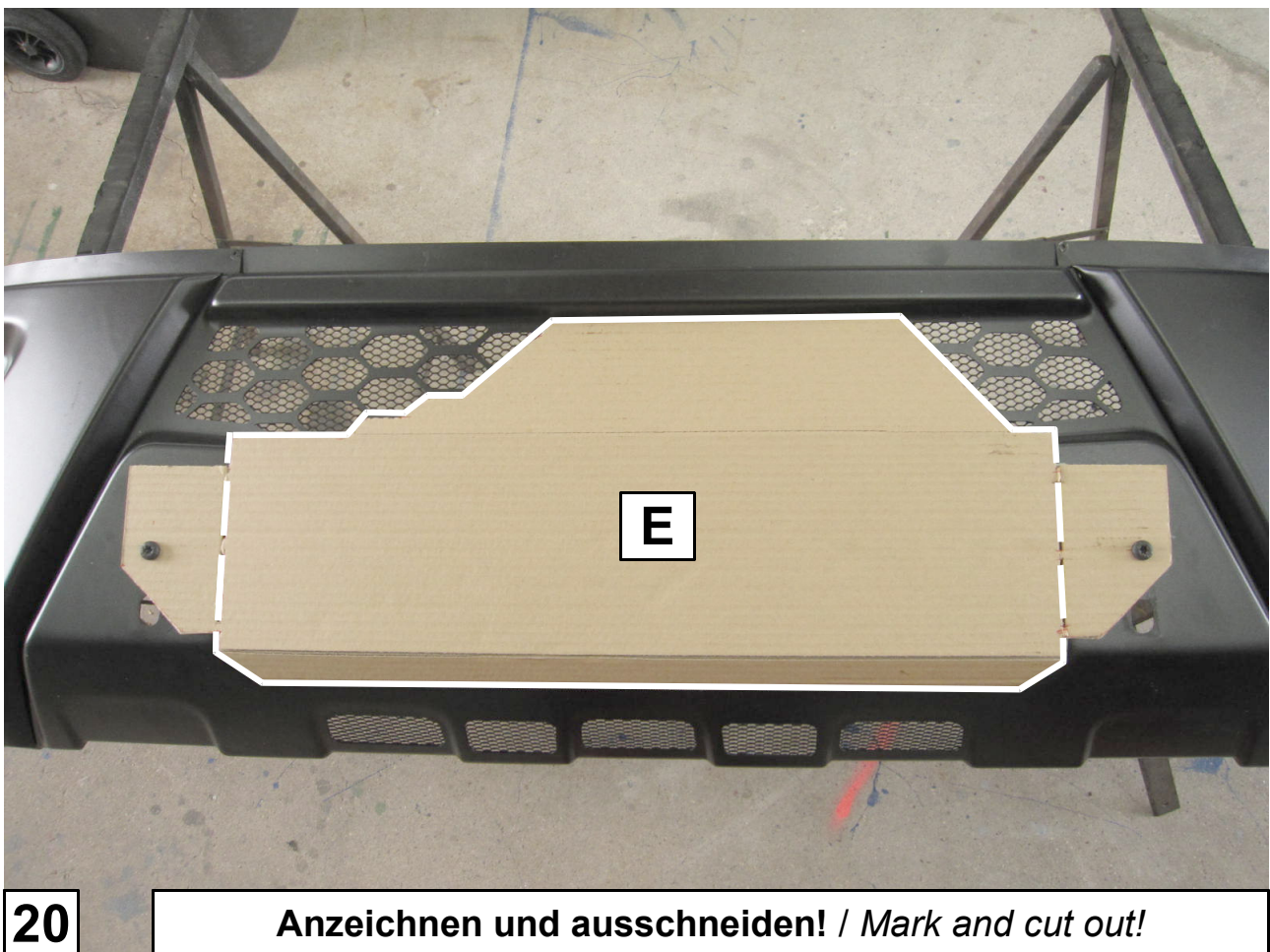
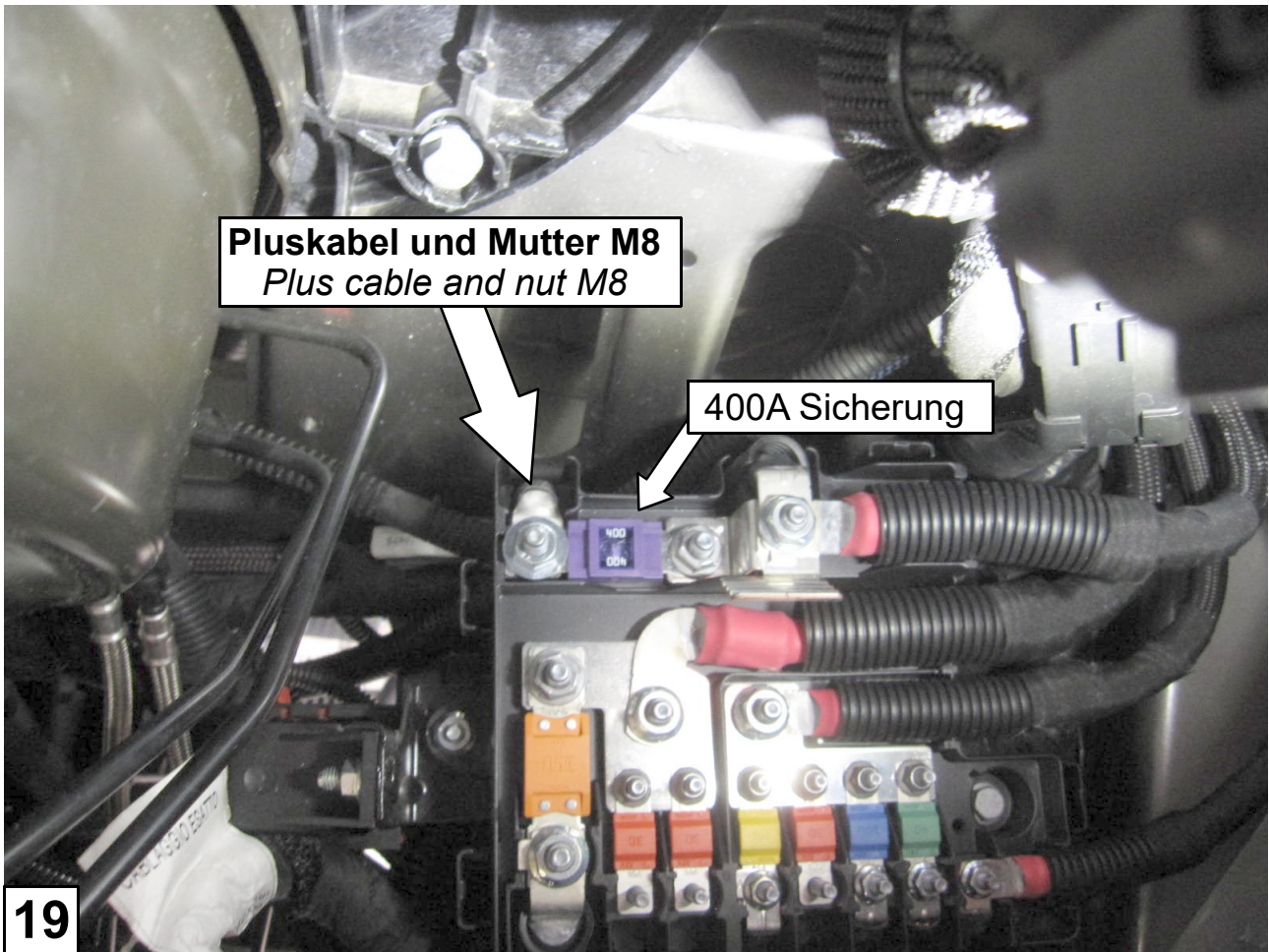

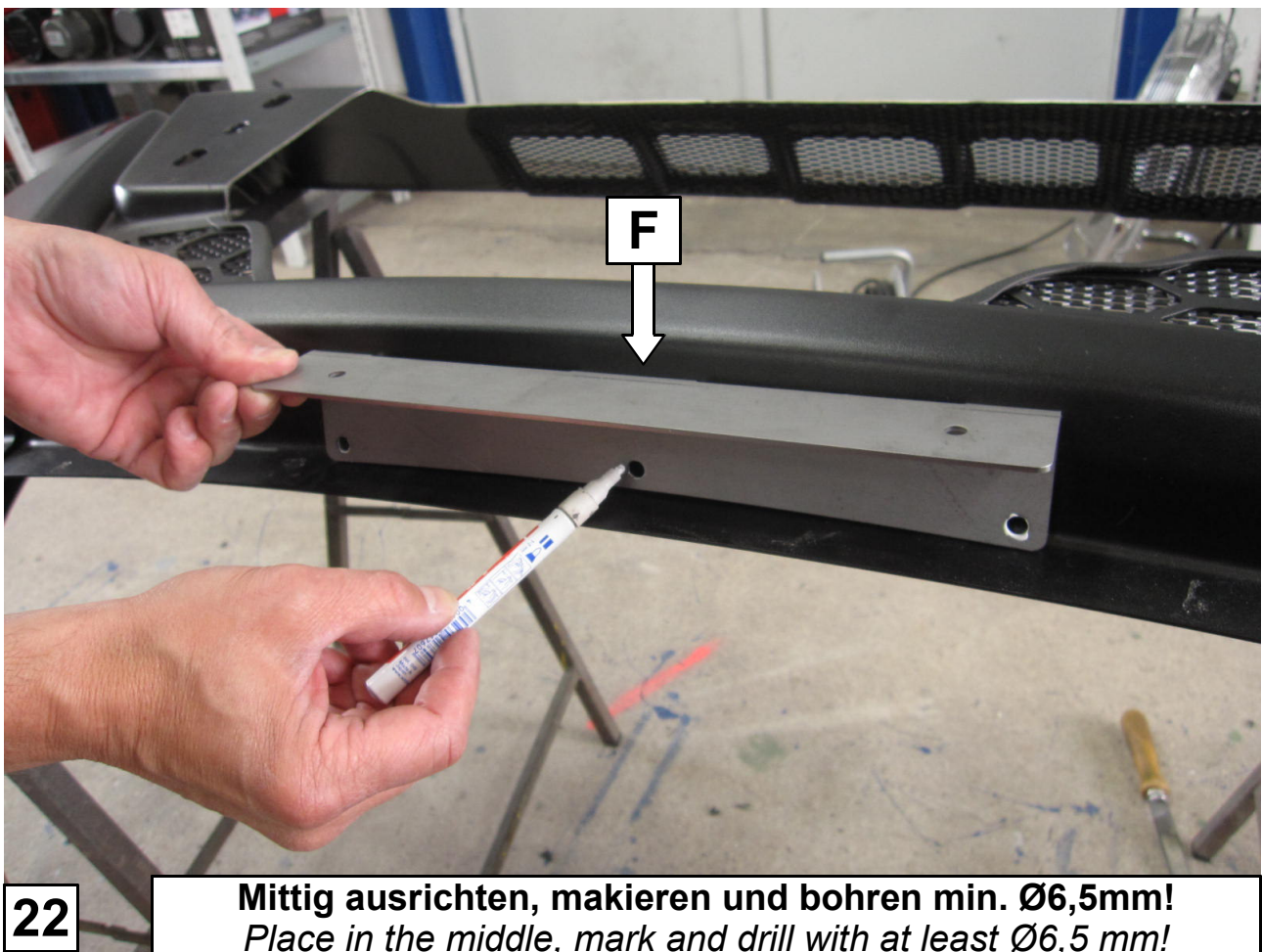
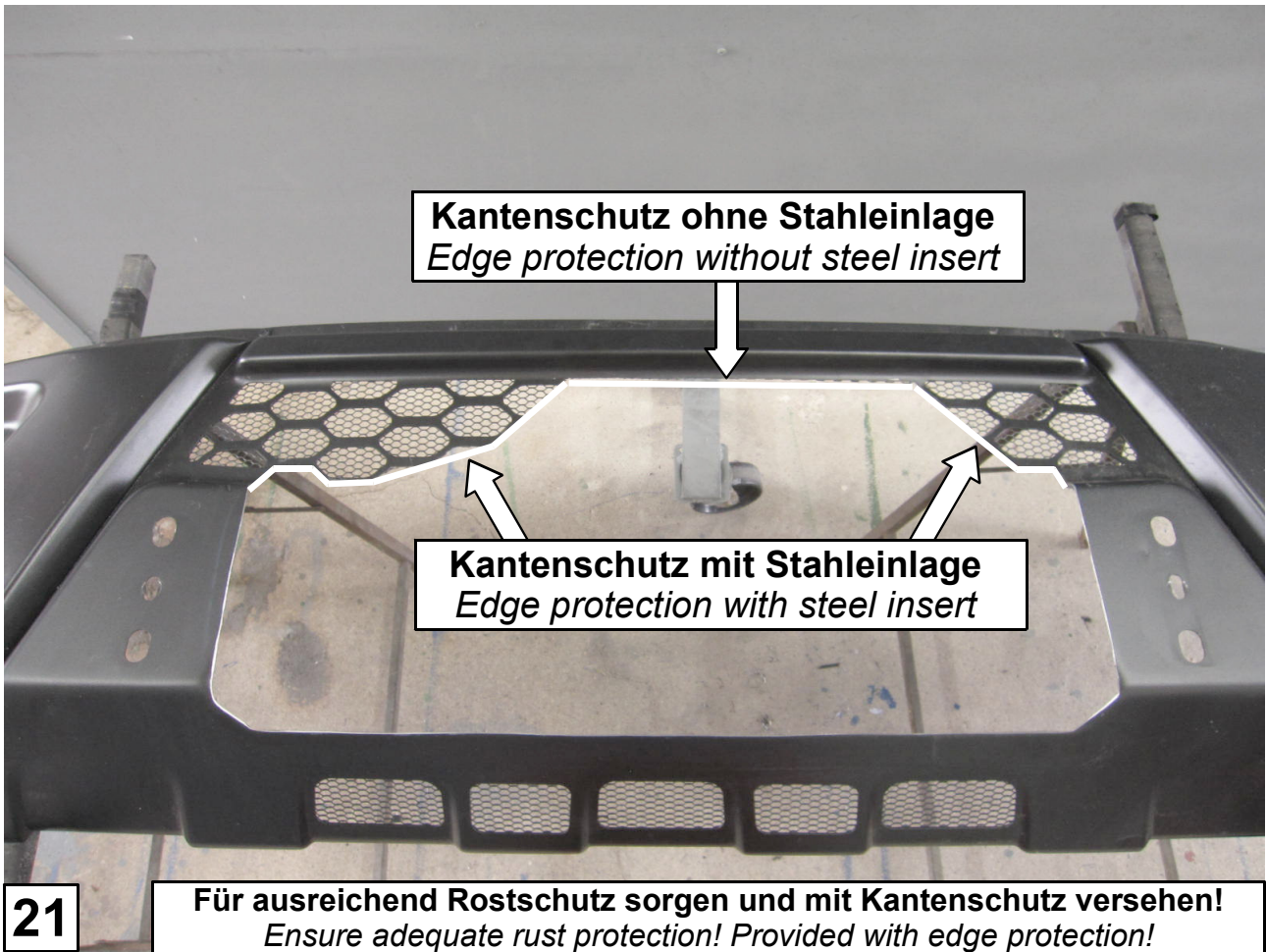

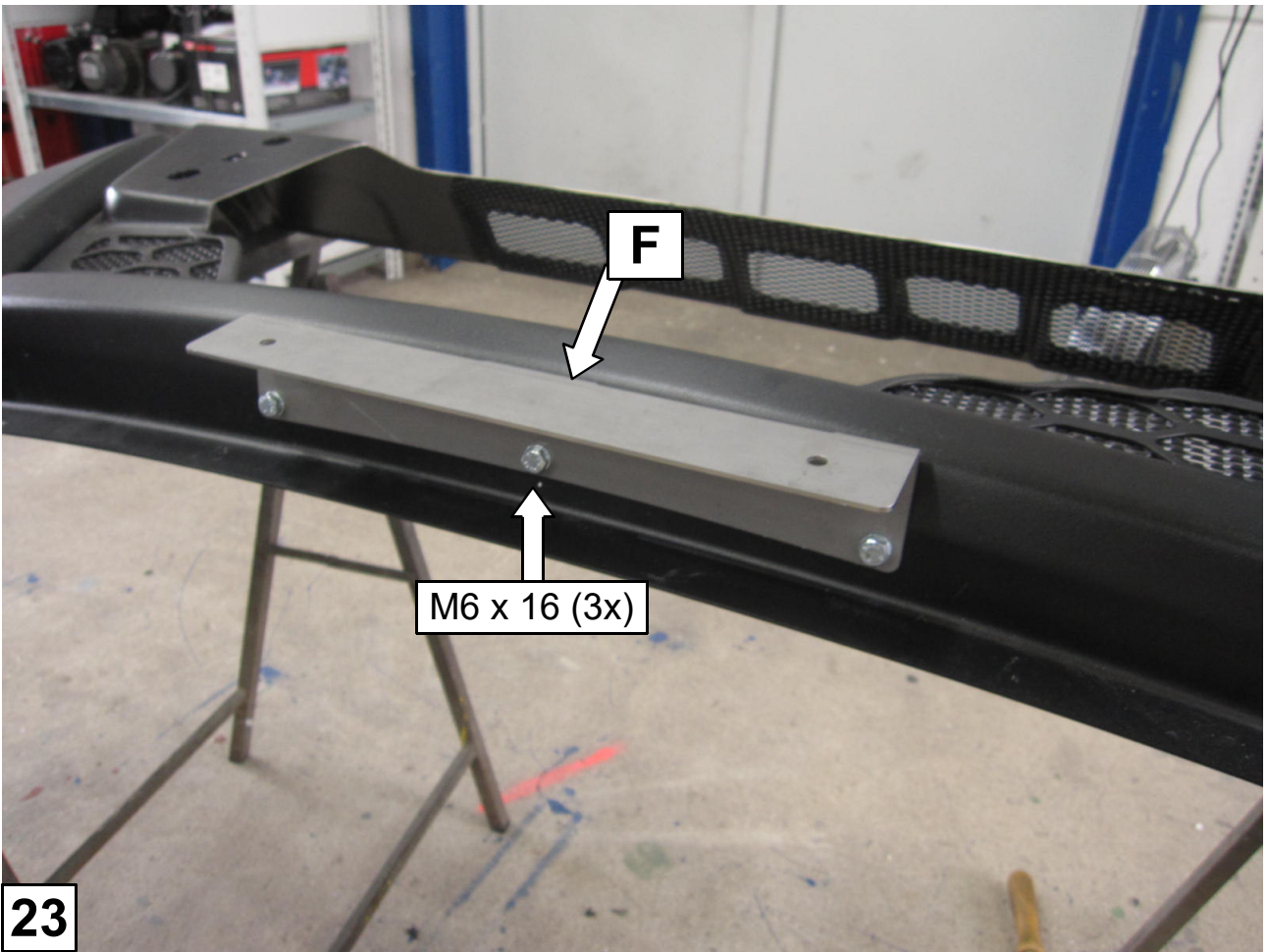

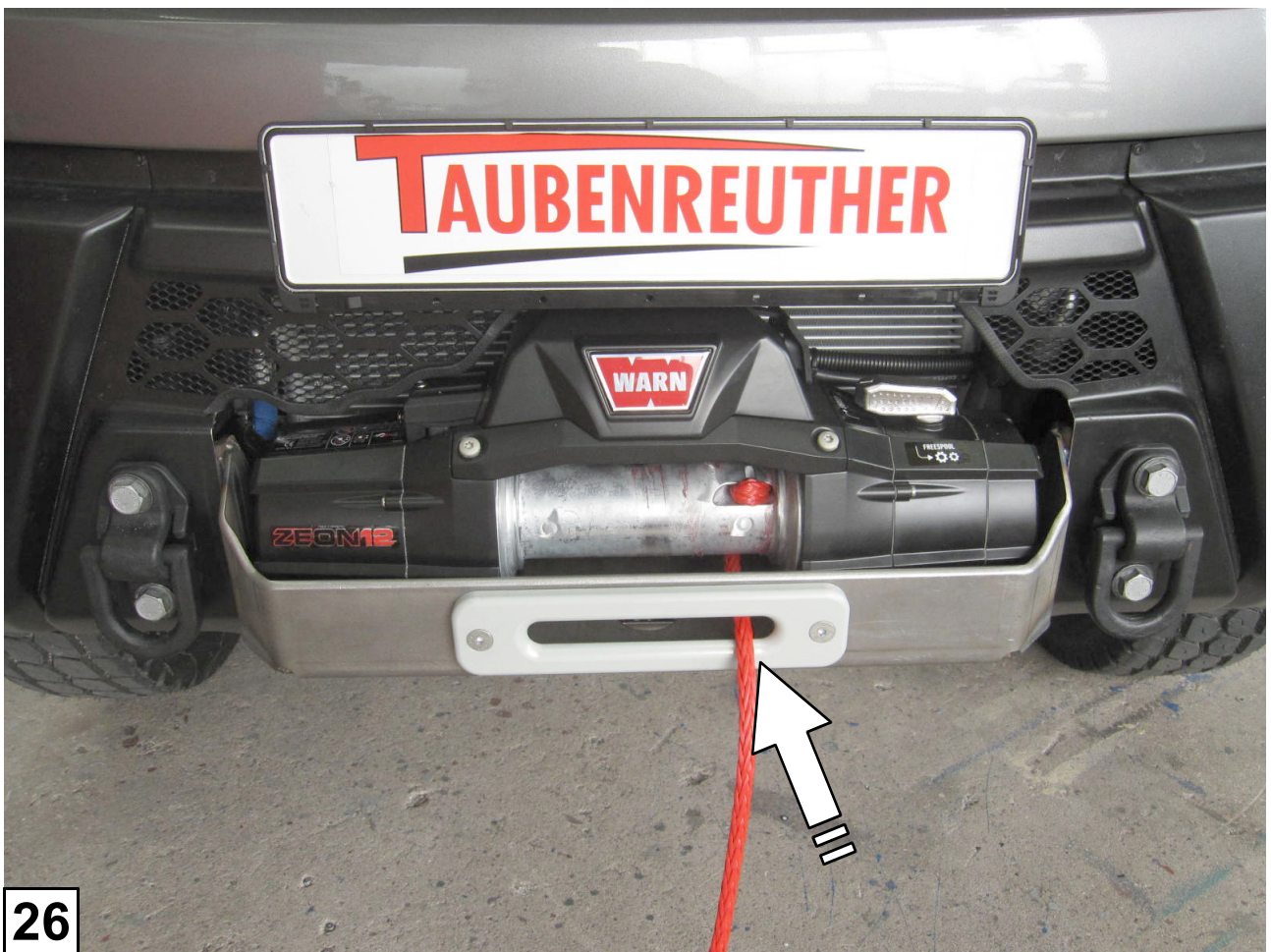



Schrauben Anzugsmomente	
Schraubengröße	Güteklasse - 8.8
M6	10 Nm
M8	25 Nm
M10	50 Nm
M12	87 Nm
M14	138 Nm
M16	210 Nm