



FITTING INSTRUCTIONS

Part Number: 3450170 F/KIT: 6173661 & 6173668

Product Description: COMBAR G/BAR CHEROKEE KJ – 05-08 SRS 8-9.5 NFO

Suited to vehicle/s: JEEP CHEROKEE KJ 05 TO 08 SRS OE FOG

Optional Fitting Kit:
3500590 – ARB FFR FOG LIGHT KIT.
3500640 - ARB AUX FOG LIGHT ADAPTOR
3500530 – ARB AUX FOG LIGHT LOOM - NON FACTORY FOG LAMP VEHICLES.
3500680 – FOG LAMP HOUSING CLEAR LENSE KIT.

WARNING

REGARDING VEHICLES EQUIPPED WITH SRS AIRBAG:

When installed in accordance with these instructions, the front protection bar does not affect operation of the SRS airbag.

ALSO, NOTE THE FOLLOWING:

- ◆ This product must be installed exactly as per these instructions using only the hardware supplied.
- ◆ In the event of damage to any bull bar component, contact your nearest authorised ARB stockist. Repairs or modifications to the impact absorption system must not be attempted.
- ◆ Do not use this product for any vehicle make or model, other than those specified by ARB.
- ◆ Do not remove labels from this bull bar.
- ◆ This product or its fixing must not be modified in any way.
- ◆ The installation of this product may require the use of specialized tools and/or techniques
- ◆ It is recommended that this product is only installed by trained personnel
- ◆ These instructions are correct as at the publication date. ARB Corporation Ltd. cannot be held responsible for the impact of any changes subsequently made by the vehicle manufacturer
- ◆ During installation, it is the duty of the installer to check correct operation/clearances of all components
- ◆ Work safely at all times
- ◆ Unless otherwise instructed, tighten fasteners to specified torque

ARB 4x4 ACCESSORIES

Corporate Head Office

42-44 Garden St
Kilsyth, Victoria
AUSTRALIA 3137

Tel: +61 (3) 9761 6622
Fax: +61 (3) 9761 6807

Australian enquiries
North & South American enquiries
Other international enquiries

sales@arb.com.au
sales@arbusa.com
exports@arb.com.au

www.arb.com.au

GENERAL CARE AND MAINTENANCE

By choosing an ARB Bar, you have bought a product that is one of the most sought after 4WD products in the world. Your bar is a properly engineered, reliable, quality accessory that represents excellent value. To keep your bar in original condition it is important to care and maintain it following these recommendations:



- Prior to exposure to the weather your bar should be treated to a Canuba based polish on all exposed surfaces. It is recommended that this is performed on a six monthly basis or following exposure to salt, mud, sand or other contaminants.
- As part of any Pre Trip Preparation, or on an annual basis, it is recommended that a thorough visual inspection of the bar is carried out, making sure that all bolts and other components are torqued to the correct specification. Also check that all wiring sheaths, connectors, and fittings are free of damage. Replace any components as necessary. This service can be performed by your local authorized ARB Stockist.

FITTING REQUIREMENTS

REQUIRED TOOLS FOR FITMENT OF PRODUCT:

METRIC SOCKET SET	METRIC RING AND OPEN ENDED SPANNER SET
ELECTRIC DRILL 13 MM CAPACITY	10mm & 12mm DRILL BIT
SMALL EXT CIR CLIP PLIERS	PHILLIPS AND FLAT BLADE SCREW DRIVER SETS
MASKING TAPE	FELT TIP MARKER PEN
TORX KEY T-15	KEYHOLE SAW
FINE FILE OR SANDPAPER	

HAVE AVAILABLE THESE SAFETY ITEMS WHEN FITTING PRODUCT:

Protective eyewear		Hearing protection	
--------------------	---	--------------------	---

NOTE: 'WARNING' notes in the fitting procedure relate to OHS situations, where to avoid a potentially hazardous situation it is suggested that protective safety gear be worn or a safe work procedure be employed. If these notes and warnings are not heeded, injury may result.

FASTENER TORQUE SETTINGS:

SIZE	Torque Nm	Torque lbft
M6	9Nm	7lbft
M8	22Nm	16lbft
M10	44Nm	32lbft
M12	77Nm	57lbft

PART LISTING

APPLICATION	PART No	QTY	DESCRIPTION
IMPACT ABSORBER MOUNTING SYSTEM	6151232	10	BOLT M10 x 30mm
	4581040	10	WASHER FLAT M10
	4581048	10	WASHER SPRING M10
	4601044	2	CHANNEL CAPTIVE NUT (INSIDE CHASSIS RAILS)
	4601045	2	CHANNEL CAPTIVE NUT (INSIDE CROSSMEMBER)
	3756772	1	MOUNTING SYSTEM
BULL BAR TO IMPACT ABSORBERS	6151232	6	BOLT M10 x 30mm
	4581048	6	WASHER SPRING M10
	4581040	8	WASHER FLAT M10
	6151026	2	NUT M10
CONTROL BOX BRACKET	6151021	2	BOLT M8 x 20mm
	4581044	2	WASHER FLAT M8
	3751564	1	CONTROL BOX BRACKET
	6151132	2	NUT FLANGE M8
NUMBER PLATE BRACKET	6151180	2	BOLT M6 x 20mm (BRACKET TO BAR)
	6151046	4	WASHER FLAT M6 x 13mm
	6151128	4	NUT FLANGE M6
	6151017	2	BOLT M6 x 16mm (NUMBER PLATE TO BRACKET)
	3751370	1	NUMBER PLATE BRACKET
INDICATORS TO BULL BAR	6821287	1	LED INDICATOR/CLEARANCE KIT PAIR
	6821116	4	NYLON PLUGS
	180302	4	CABLE TIES
8-9000lb WINCH	4581040	4	WASHER FLAT 3/8" x 1"
	6151074	2	BOLT 1 3/4" x 3/8" UNC
	180302	6	CABLE TIES
WINCH PAN COVER	6191005	1	EXTRUSION RUBBER
	6521031	1	PANEL WINCH COVER
	6151256	2	SCREW BUTTON HEAD M6 x 16mm
	6151128	2	NUT FLANGE M6
AIR DEFLECTOR	6522656	1	AIR DEFLECTOR
	6151017	4	BOLT M6 X 16mm
	6151128	4	NUT M6 - FLANGE
	4581072	4	WASHER FLAT M6 x 20mm
WASHER BOTTLE COVER	6522655R	1	PANEL WING KJ JEEP 05
	6522655L	1	PANEL WING KJ JEEP 05
	6151300	6	CAGE NUT M6 (3mm PLATE)
	6151180	14	BOLT M6 x 20
	4581072	14	WASHER FLAT M6 x 20mm
	4581036	6	WASHER SPRING 1/4"
	6151128	8	NUT FLANGE M6
FOG LAMP HOUSINGS TO BULL BAR	3163082	1	FOG LAMP HOUSING KIT
INNER GUARD TO BAR	6151017	4	BOLT M6 x 16mm
	4581072	4	WASHER FLAT M6 x 20mm
	6151128	4	NUT FLANGE M6

FITTING PROCEDURE – PREPARATION TO VEHICLE



1. Remove the grille from the vehicle using torx-keys.
2. Remove the bumper from the vehicle and disconnect the turn signal lights. If the vehicle is fitted with fog lamps, as shown in the adjacent photo, remove the fog lamps.
3. Be careful when removing bumper from the flares, as the plastic clips are awkward to undo.
4. Remove the turn signal lights.



5. When bumper is removed, cut the lower plastic lug from grille panel to enable bull bar mounting system to bolt up against vehicle crossmember. Place either thick cardboard or plywood either side of lug to prevent paint damage.

Keep the fasteners used on the original bumper as some will be re-used on the new bull-bar.



6. This is how the grille panel should appear after cutting.
7. Remove tow hook and crush cans from vehicle.



8. To fit the mounting system to the vehicle, fit the captive nut channel in through the front apertures in the vehicle crossmember on both sides.

Note: (Notch in channel must face front of vehicle)

PREPARATION TO VEHICLE (Continued)



9. When both channels are inside the crossmember, using your finger, align with the holes underneath the chassis rails.

10. Fit mounting system to the front crossmember of vehicle and centralize sideways.



11. Fit 10mm hardware to the two most forward holes in the lower brackets, on both sides of the vehicle making sure mounting system is hard up against vehicle crossmember. Tighten firmly.

Note: Photo shows underside of mounting system on LHS of vehicle.



12. Using 10mm drill bit, drill out the holes in the centre of the slots in the front of the crossmember.



PREPARATION TO VEHICLE (Continued)



13. Once the holes have been drilled, fit captive nut channels through the lower aperture in the vehicle crossmember.



14. Secure using 10mm hardware and tighten firmly making sure mounting system is hard against vehicle crossmember.

Note: When Step 16 is finished, slacken off bolt tension to enable sideways movement if needed when bar is fitted.



15. When the front bolts are tightened, loosen off the lower bolts in the chassis brackets.
16. Using a 10mm drill bit, drill out the most rearward hole in the lower chassis bracket being careful not to drill too far into captive nut channel. When the holes have been drilled, realign the rear hole with the rear nut in captive nut channel, and secure using 10mm hardware. Lightly tighten all bolts in the lower chassis brackets.



NOTE: MOUNTING SYSTEM MUST BE ABLE TO BE MOVED SIDWAYS.

PREPARATION TO VEHICLE (Continued)

17. Optional Fog Lamp Fitment:

For vehicles with Factory Fog lamps:

Connect RH & LH Fog Lamp wiring using 3500640-ARB Aux fog light adaptor and connect to Factory Fog Lamp loom.

For vehicles without Factory Fog lamps:

Connect RH & LH Fog Lamp wiring using Fog Lamp Wiring Loom kit – 3500530.

18. Connect the LED indicator/clearance harnesses to the vehicle using the wiring looms (6821286) and scotch locks provided in the LED indicator/clearance kit (6821287).

(See table for wire colours).

Summary of Wire Connections.

FUNCTION	TURN SIGNAL HARNESS	VEHICLE PARK LAMP	
		RIGHT	LEFT
PARK LAMP	RED	GREEN / YELLOW	YELLOW / BLACK
		VEHICLE INDICATOR	
		RIGHT	LEFT
EARTH	BLACK	BLACK	BLACK
INDICATOR	GREEN	RED	RED

PREPARATION TO BULL BAR

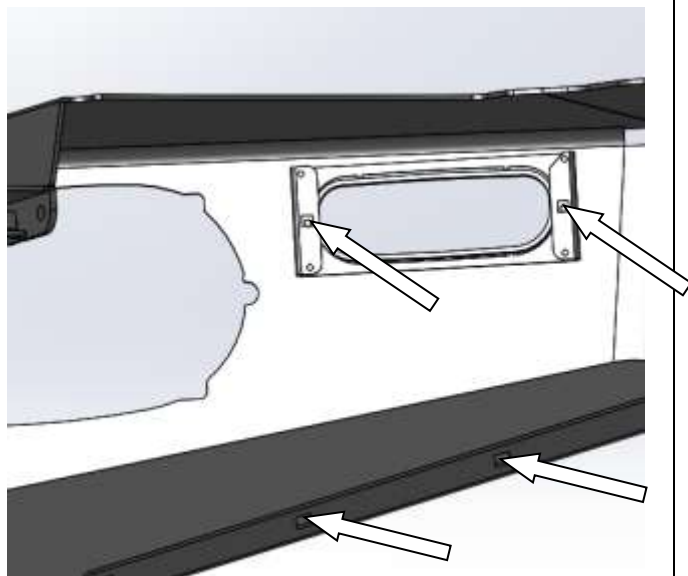

19. Install Nylon plugs (6821116). (4 off) Into Clearance Light/Turn Signal Brackets. (RH Shown).

20. Fit the M6 cage nuts to mount the washer bottle/horn stone guards.

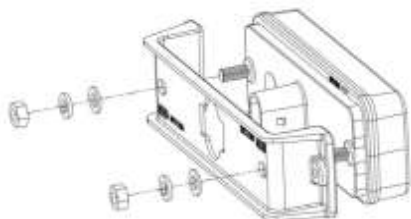

21. Install 6821285 bracket onto LED lamp with 2 x flat washer, 2 x spring washers and 2 x M6 nuts as shown.

Torque to specification.



M6 - 3 Nm.

NOTE: Do not over-tighten.

PREPARATION TO BULL BAR (Continued)

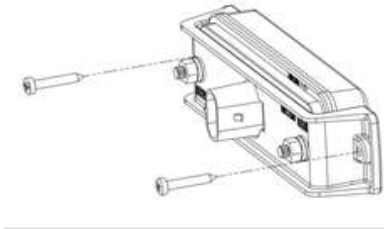
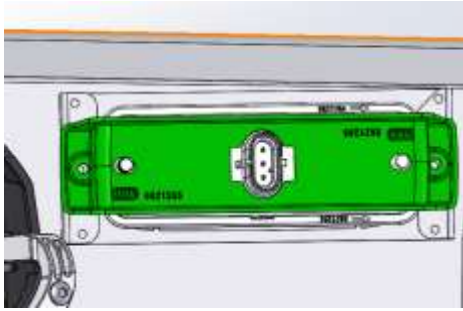

22. Install LED lamp with bracket into bull-bar using 2 x 15mm mounting screws provided. (RH Shown).

Note: Do not fully tighten.

IMPORTANT: The clearance LEDs must be on the outboard edge of the bull-bar. To achieve this, position lamp with arrows facing outside of vehicle as shown below.

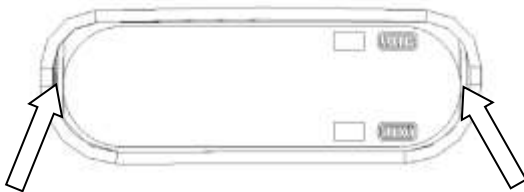
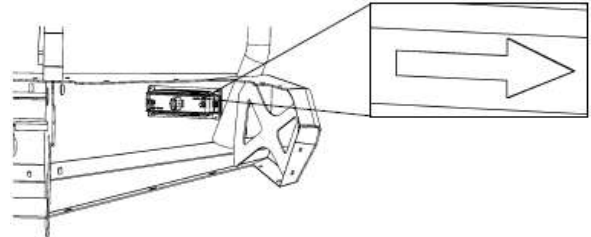

ADJUST GAPS TO BE THE SAME

23. Viewing the installed LED Lamps from the front of the bull bar – adjust the Lamp positions so that they are central in the formed apertures and any gap on either side is the same.

- Once adjusted fully tighten the 15mm mounting screws.

NON-WINCH FITMENT ONLY



IF FITTING A WINCH MOVE ON TO STEP 28.

24. Wrap rubber extrusion around the winch cover and trim excess.
25. Place spacer washers over the winch cover fixing holes, located on the top face of the winch bumper.
26. Place the winch cover on top of the winch bumper in line with the mount holes.

Bolt together using the M6 button head stainless steel screws and M6 nuts.

Torque to specification.



M6 - 9 Nm.



27. Fit number plate directly to the front of the bar using 6mm hardware. If desired double sided tape can be used down the sides of the number plate.

WINCH FITMENT ONLY



28. Fit number plate bracket to the bar using 6mm hardware, (20mm x 6mm bolts). Fit number plate to number plate bracket using 6mm hardware when bar is fitted to vehicle.

Torque to specification.

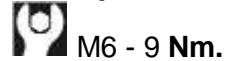

29. Fit control box bracket to bar using 8mm hardware.

Torque to specification.

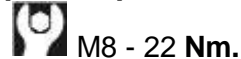

30. Drill 2 x 12mm holes 25mm lower than the existing holes using the same pitch. These holes will be used to mount the fair lead to the bull bar.

(New holes indicated).



31. To fit winch into the bull bar you must pack the winch up on a bench to enable you to lower bar down on to the winch.

32. Line up the top holes first and secure using 3/8" hardware (1 1/2" x 3/8" bolts) flat and spring washers.

33. Place roller fairlead over lower holes and again secure using 3/8" hardware (1 3/4" x 3/8" bolts) flat and spring washers. When all bolts are fitted tighten firmly.



WINCH FITMENT ONLY (Continued)



34. Fit control box to control box bracket using original 1/4" nuts from control box and connect power cables to winch motor as per winch instructions.



35. Cable tie power cables to the bull bar keeping cables clear from all moving parts.

(Optional driving lights fitted).

Fasten control box earth to winch tie rods.



36. Cable tie the battery power leads to the left side of the bar keeping them clear of all moving parts.



37. Position the bull bar in front of the vehicle and connect the indicators, fog lights and fit the winch cables under the grille and into the engine bay close to battery.

BULL BAR FITMENT TO VEHICLE



38. Using two people, three if a winch is fitted, position the bar assembly on the vehicle mounts and secure using 10mm hardware. Place rags between the bull bar and the vehicle's grill to avoid the grill being scratched.

Prior to bolting the bull bar in place ensure the vehicles mudguards are tucked inside the bull bar wings as indicated.

39. Align bar with vehicle grille and flares, and tighten bolts using socket, extension and a universal joint through fog light aperture in the bull bar. Lastly retighten mounting system bolts when bar has been centralized sideways.

40. Once the bull bar is in position, fasten the wheel liners to the bull bar using the M6 hardware. Drill through the wheel liner using the lower wing hole and fasten.



41. Once the bull bar is secured to the vehicle, use the holes in the locking plates as a template to drill 10mm holes through lower section of bar and bolt up using 10mm hardware.

Torque to specification.

 M10 – 44 Nm.



BULL BAR FITMENT TO VEHICLE (Continued)

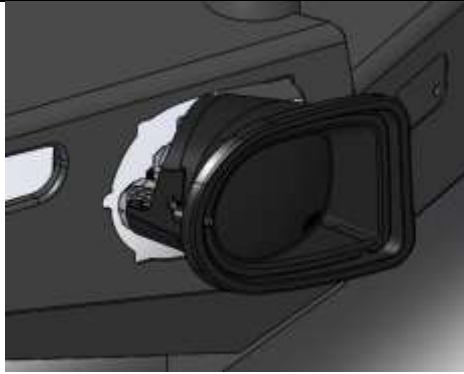

42. Fit fog lamp housings (3163082) into the bull-bar fog lamp cutouts as shown. (RH Shown).

If fitting fog lights refer to fitting instructions (3789190) in the fog lamp housing kit (3163082) for details before mounting the housings in the bull-bar.

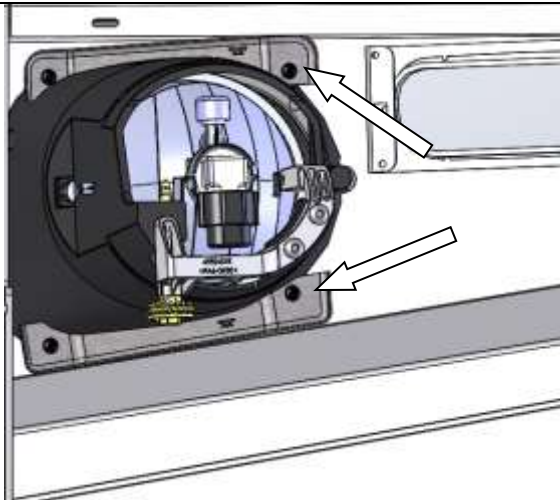

43. Secure into position as indicated using the 2 x fog lamp clamps and 4 x self-tapping screws.

(RH Clamps Part No. 3759115R).
(LH Clamps Part No. 3759115L).

Note: Shown with generic Fog Lamp fitted in this view.

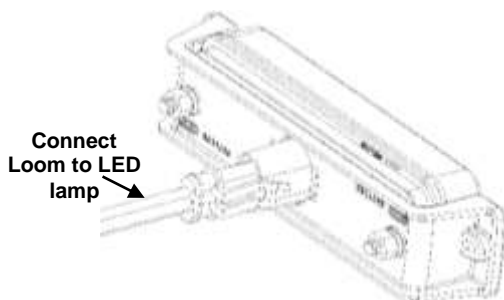

44. Connect the indicator/clearance lamps to the looms fitted during Steps 18.

45. If fitting fog lamps connect the fog lamp harnesses fitted at Step 17 to the fog lamps.

- **Cable-tie all wiring and wiring looms into safe and convenient locations.** Ensure that all cables are installed well clear of all sharp or moving parts using cable-ties from the bolt kit.
- **Check that all lights work correctly.**
- **Check and test winch if fitted.**

BULLBAR FITMENT TO VEHICLE (Continued)

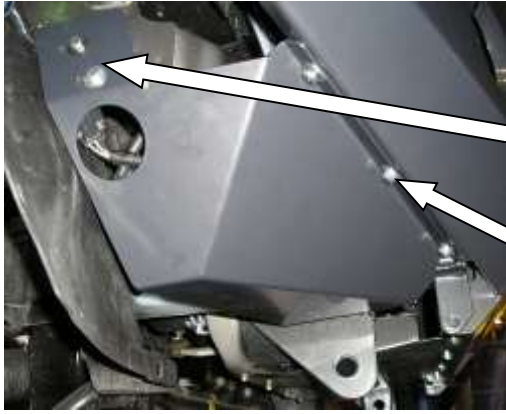

46. Fit washer bottle guard bracket to bar mounting system using 6mm hardware.

M6 x 20 bolts, M6 flat washers & M6 flange nuts.

M6 x 20 bolts, M6 spring washers & M6 flat washers.

M6 x 20 bolts, M6 flat washers & M6 flange nuts.

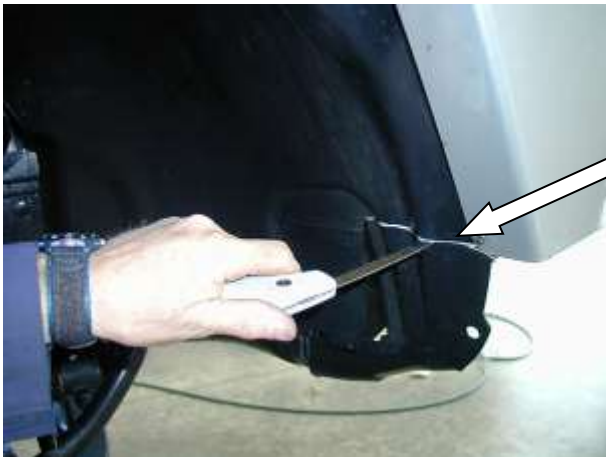

47. Next step is to trim the plastic inner guards that hang down past the bar. Cut plastic level with the bottom of bar wing section to washer bottle guard.



48. Fitting of AIR DEFLECTOR to underside of bar.

49. Fit rear of air deflector to vehicle lower crossmember using original screws and front to bar using 6mm hardware. When all hardware is fitted, tighten firmly.

The two middle screws were removed elsewhere with the bumper and will be used here. These screws will be self-thread cutting as required.

HI LIFT JACK POSITION



50. Position for Hi Lift jacking point.

51. (If installing bull bar with a winch).

Connect the long winch + & - cables to the vehicle after the bar is installed.

Refer to the Warn winch manual for vehicle wiring instructions.

Ensure that these cables are installed well clear of sharp, hot or moving objects. Secure the winch cables to the vehicle and winch bumper with the supplied cable ties.

ONCE BAR IS FITTED:

- ◆ Ensure all bolts are tensioned correctly
- ◆ All wiring is clear of sharp edges or moving surfaces and secured properly
- ◆ Piping is secured well away from sharp or moving components
- ◆ Check operation of winch if fitted
- ◆ Check all wiring and connections to turn signal lamps, sensors, headlamp washers etc. are functioning correctly.

FITTED PRODUCT



PHOTO SHOWS COLOUR CODED BAR.